

Spring loaded resistance thermometer

THERMOWELL & REPLACEABLE INSERT

C200-201-204-205-260-262
CONFIGURATIONS

Ex ia RTD

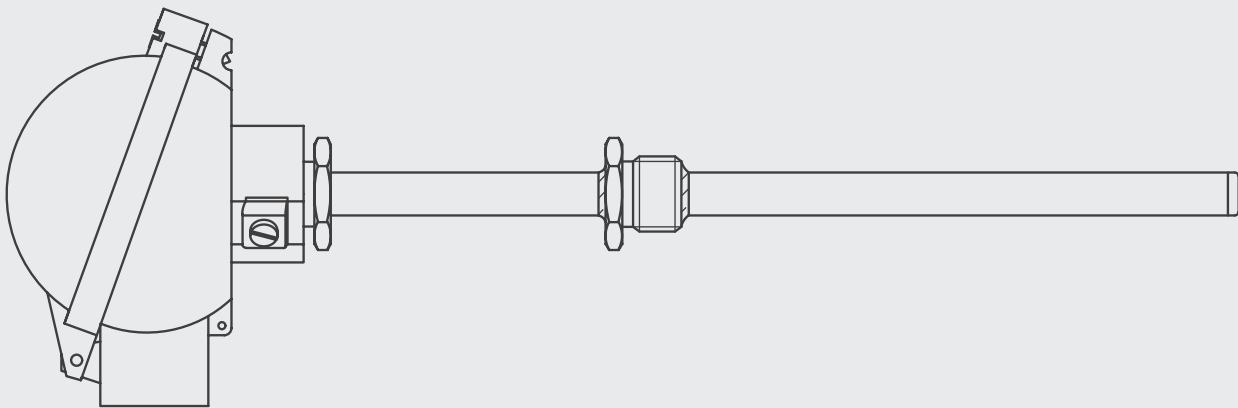

RODAX^o
new temperature solutions

Product series PT100RI/WI

C200

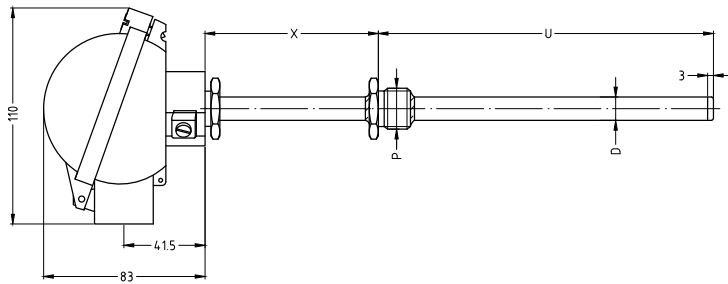

C201

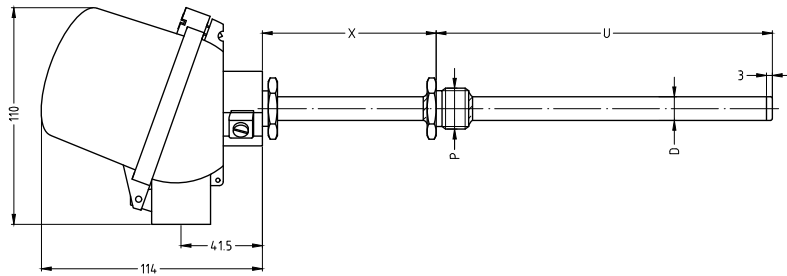

C204

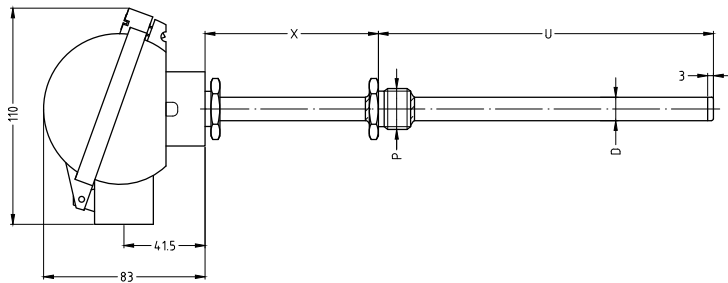

C205

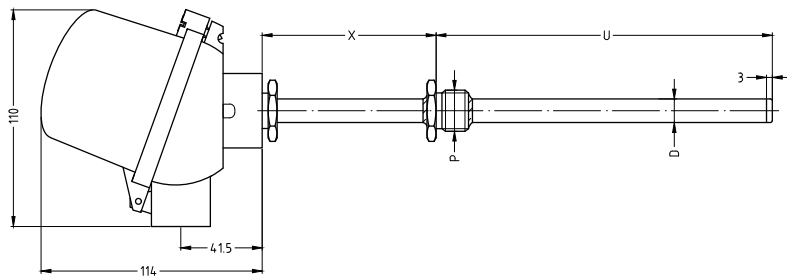

C260

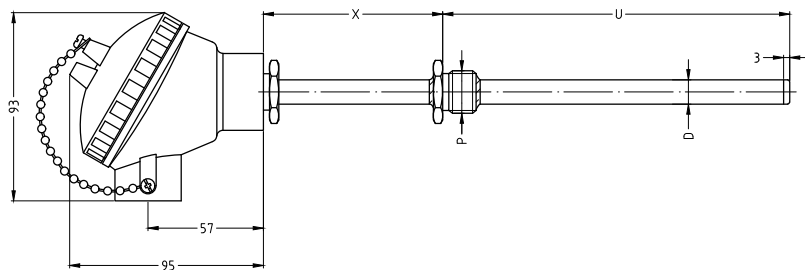

C262

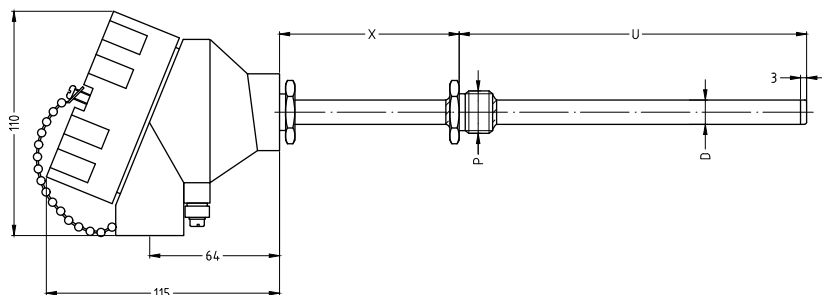

Features assembly

The industrial spring loaded configuration guarantees a positive contact between the sensing part of the temperature probe and the bottom of the thermowell, thus reducing the response time.

Threaded process connection.

The assemblies can be delivered with an aluminium or stainless steel connection head combined with a high quality thermocouple element with MgO mineral insulated metal sheathed cable, providing excellent stability and reproducibility.

Sensor diameters up to 12,7mm.

Technical specification assembly

- Connection head aluminium (C200-C201-C204-C205-C260-C262).
- Ambient temperature range assembly: -45/+80 °C; this can be limited depending on the materials applied or in case a temperature transmitter is used.
- IP-68 protection degree (body – cover) with silicone rubber O-ring. The assembly protection degree (IP-68) can be attained but depends on the use of correct cable gland(s) and on the correct mounting to thermowells.
- Cover: hinged type or screw type with chain.
- Several sensor diameters and lengths are possible.

Table 1: Configuration

Connection head type

Choice between:

- Connection head types C200 / C201 / C204 / C205 with hinged type cover with 1 or 2 conduit openings.
- Connection head types C260 / C262 with screw type cover with 1 or 2 conduit openings.
- Connection head supplied with O-ring in silicone rubber (between body and cover). Head supplied with external earth terminal.

	Conduit	Material	Coating	Colour
C200	00C1 1x conduit	Aluminium	Epoxy Corrosion category EN ISO 12944-2: C4	RAL5015 Sky blue
C201	01C1 1x conduit	Aluminium	Epoxy Corrosion category EN ISO 12944-2: C4	RAL5015 Sky blue
C200/201	00C2/01C2 2x conduits	Aluminium	Epoxy Corrosion category EN ISO 12944-2: C4	RAL5015 Sky blue
C204	04S1 1x conduit	Polyamide PA12 (Antistatic)	None	Black
C205	05S1 1x conduit	Polyamide PA12 (Antistatic)	None	Black
C260	60C1 1x conduit	Aluminium	Epoxy Corrosion category EN ISO 12944-2: C4	RAL5015 Sky blue
C262	62C2 2x conduits	Aluminium	Polyurethane spray on primer Corrosion category EN ISO 12944-2: C5-M	RAL5015 Sky blue

Table 2: Measuring inserts main models

	Terminal	Total spring	
PCC	Ceramic spring loaded terminal block 2/3/4/6 or 8 terminals	10 mm We recommend a spring loading of +/-5 mm	
PCB	Hi-tech spring loaded thermoplast (moisture and shock proof) terminal block 2/3/4 or 6 terminals	40 mm We recommend a spring loading of +/-20 mm	
PCA	Hi-tech spring loaded thermoplast (moisture and shock proof) terminal block 2/3/4 or 6 terminals	10 mm We recommend a spring loading of +/-5 mm	
PFA	Spring loaded mounting plate with flying leads of 150 mm	10 mm We recommend a spring loading of +/-5 mm	

Table 3: Equipment for potentially explosive atmospheres

Certification

A	ATEX
I	IECEX
G	GOST-R

Explosive atmosphere

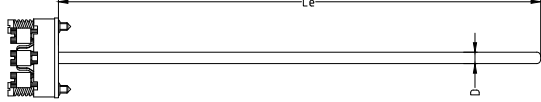
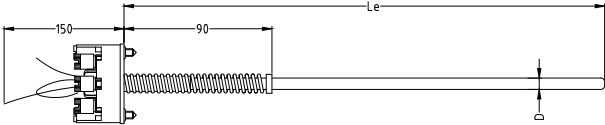
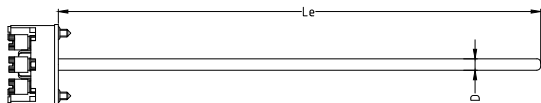
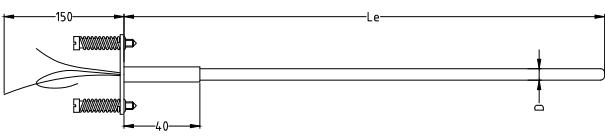
G	Gas
D	Dust

Table 4: Measuring inserts details

Details

- Maximum temperature: 550 °C
- Minimum insulation resistance: 1000 MOhm at 500VDC, T_{amb}=20 °C
- Conductors: material Cu
- Metal sheath: SS321 / 1.4541

PT100 element

S	D	Option	HV
Single	Double		High vibration

Diameter ØD

D3	D3,2	D4,5	D4,8	D6	D6,35	D8	D9,53	D12,7	Other diameters on request
3,0 mm	3,2 mm	4,5 mm	4,8 mm	6,0 mm	6,35 mm	8,0 mm	9,53 mm	12,7 mm	

Electrical connection

W2	W3	W4 (*)	(*) for OD 3 mm: dual sensors max 2x3 wire
2 wire	3 wire	4 wire	

Accuracy

A1	A3	A5	A6	A10	Other accuracies on request
Class A IEC EN 60751 $\pm(0.15+0.002 t)^{\circ}\text{C}$	1/3 DIN 1/3 class B	1/5 DIN 1/5 class B	1/6 DIN 1/6 class B	1/10 DIN 1/10 class B	

Table 5: Thermowell–Protection tube

Protection tube

Stainless steel tube with 3 mm welded plug with rotatable or not-rotatable connection to head. Threaded connection to the process.

Material Protection tube

M2108	M2102	M2110/8	M0601	M0805	Other materials on request
SS316L	SS304L	SS310/310S	Inconel 600	Hastelloy C276	

Dimensions Protection tube

D0610	D0810	D1015	D1215	D1425	Other dimensions on request
6 mm OD x Wall 1 mm	8 mm OD x Wall 1 mm	10 mm OD x Wall 1,5 mm	12 mm OD x Wall 1,5 mm	14 mm OD x Wall 2,5 mm	

Positioning connection head

YR	Rotatable connection head
NR	Fixed connection head

Process connection

P163	P173	P205	P206	P207	P405	P406	P407
M18 x 1,5	M20 x 1,5	G1/2"	G3/4"	G1"	½"NPT	¾"NPT	1"NPT

Dimensions extension tube

OD tube		X
STD	... mm	X
Same as tube	Reinforced	Length in mm

Insertion length

U	Length in mm
----------	--------------

Table 6: Connection head details

Connection head single/double conduits (SC/DC)

SC173	SC405	DC173	DC405
1X M20x1.5	1X ½"NPT	2x M20x1.5	2X ½"NPT

Table 7: Connection head accessories

Available options

- Option 1: For SC and DC connection heads: Cable gland(s) only**

If required, a cable gland can be supplied; please use the letter 'CG' (cable gland) followed by the material of the cable gland and used cable diameter. Specification see below table.

The offered cable glands are II2 G Ex d/e IIC Gb and II 2D Ex tb IIIC Db IP66 certified and can be combined with configured products in this datasheet.

For SC heads, only option 'one cable gland' is possible. For DC heads, both one and two cable glands are possible.

- Option 2: For DC connection heads: One conduit plugged**

Please use the letter 'P' (plug) followed by the material of the plug, see below table. The remaining conduits stay open.

- Option 3: For DC connection heads: Cable gland + one conduit plugged**

Please use the combination 'PCG' (plug cable gland) followed by the material of the plug and cable gland, see below table.

		Option 1	Option 2	Option 3
Material	Brass	CGM0200	PM0200	PCGM0200
	Nickel plated brass	CGM0210	PM0210	PCGM0210
	Stainless steel SS316	CGM2107	PM2107	PCGM2107
	Polyamide	CGM5006		CGM5006
Cable diameter for EPDM rubber	4 - 7 mm	D5		D5
	7 - 9,5 mm	D8		D8
	9 - 12 mm	D10		D10
	7 - 13 mm	D9 (only for CGM5006)		D9 (only for CGM5006)
Glands N°	One cable gland	N1		
	Two cable glands	N2		

Table 8: Certification possibilities

Certificates

Following tests and certificates are possible and are either done in-house or done by an external party.

Code	Certificates
Q04210	Functional test report sensor
Q04230	Calibration report (measuring points to be indicated) E.g. 0/100 °C
Q05220	Calibration report by accredited calibration lab retraceable (measuring points to be indicated)
Q05230	Calibration report by accredited calibration lab ISO/IEC 17025 (BELAC) (measuring points to be indicated)
Q02040	Test report EN10204-2.2
Q04250	Transmitter programming. Range and burn-out settings to be indicated



Addenda

Thermal data related to product series PT100RI/WI

The maximum process temperature T_p (in °C) and the relation to the temperature class is as follows:

Maximum process temperature T_p (°C)	75	90	125	190	285	435	>435
Temperature class (°C)	T6	T5	T4	T3	T2	T1	T_p+10
Maximum surface temperature T of the Assembly (°C)	85	100	135	200	300	450	T_p+10

Certificates for product series PT100RI/WI

ATEX 2014/34/EU	ATEX EU-type examination certificate 18ATEX0060 X	
IECEX 02	IECEX DEK 18.0032 X	
GOST-R	GOST EAC RU C-BE.ГБ05B.00211	

HOW TO ORDER (example)

Code		Example	Your code
Configuration	See table 1	C201	
Main model	See table 2	PCA	
Certification	See table 3	A	
Explosion atmosphere	See table 3	G	
Pt100 element	See table 4	S	
Diameter ØD	See table 4	D6	
Electrical connection	See table 4	W3	
Accuracy	See table 4	A1	
Material protection tube	See table 5	M2108	
Dimensions protection tube	See table 5	D1215	
Positioning connection head	See table 5	YR	
Process connection	See table 5	P205	
Dimensions extension tube	See table 5	STD	
Extension length X	See table 5	X100	
Insertion length U (mm)	See table 5	U200	
Connection head SC/DC	See table 6	SC173	
Connection head accessories	See table 7	CGM0200D5N1	

Ordering code example:

C201 PCA A G S D6 W3 A1 M2108 D1215 YR P205 STD X100 U200 SC173 CGM0200D5N1

For all options: please contact Rodax

© 2018

Santvoortbeeklaan 33, 2100 Antwerp - Belgium

T +32 (0)3 360 90 00

E quotationdesk@rodax-europe.com

www.rodax-europe.com

RODAX[°]
new temperature solutions

C200-Exia-RTD GB 201810