

Spring loaded resistance thermometer

THERMOWELL & REPLACEABLE INSERT

C200-201-202-203-260-262
CONFIGURATIONS

General use RTD

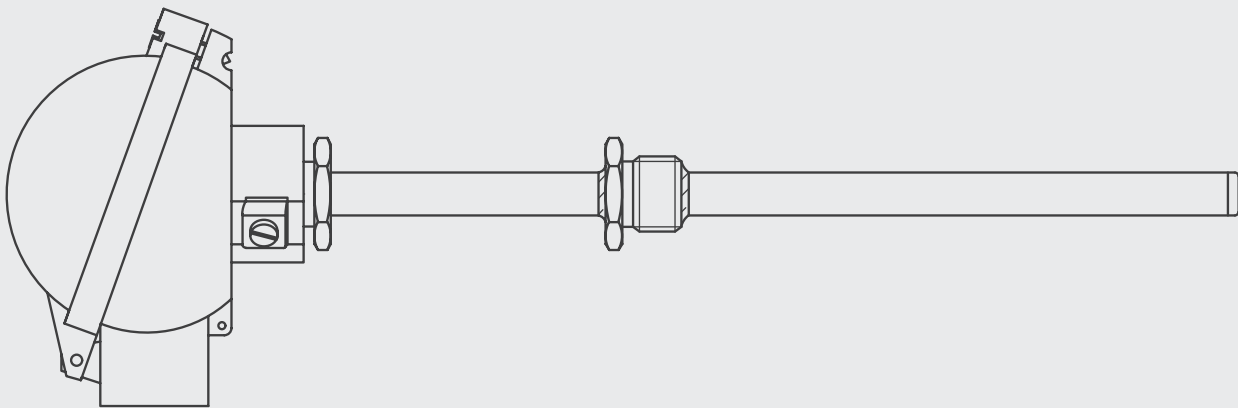

RODAX^o
new temperature solutions

Product series PT100RB/WT

C200

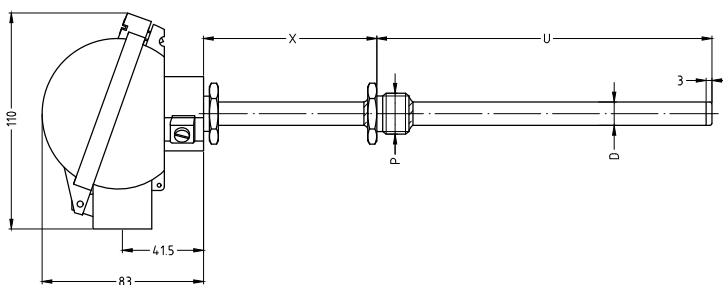

C201

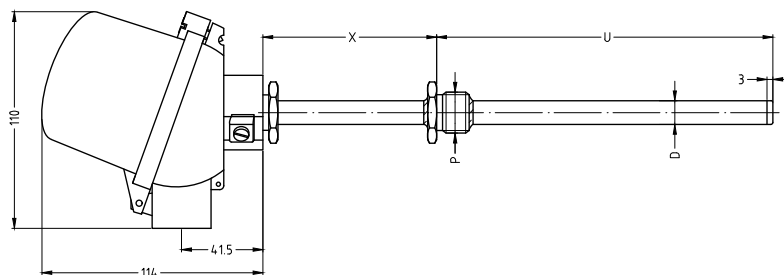

C202

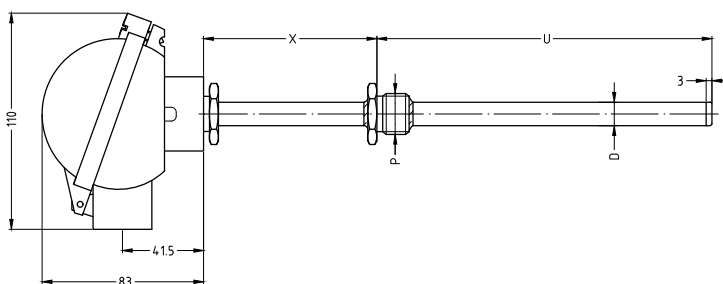

C203

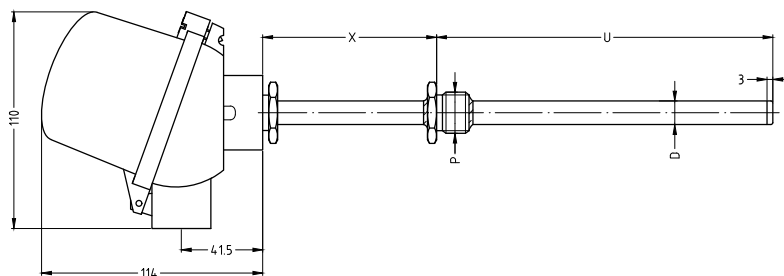

C260

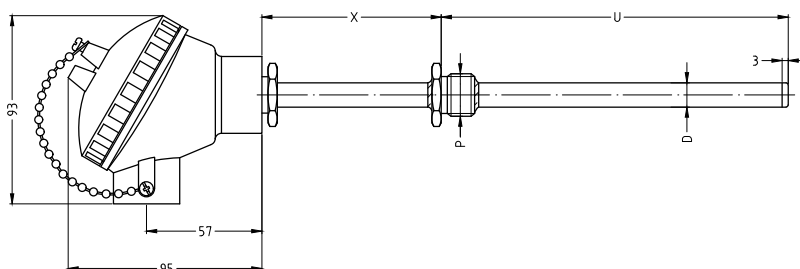

C262

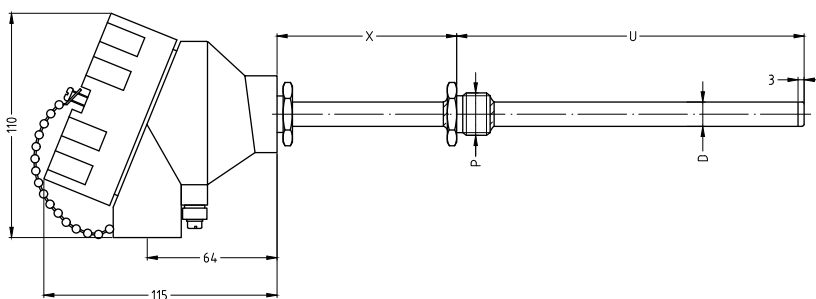

Features assembly

The industrial spring loaded configuration guarantees a positive contact between the sensing part of the temperature probe and the bottom of the thermowell, thus reducing the response time.

Threaded process connection.

The assemblies can be delivered with an aluminium or stainless steel connection head combined with a high quality thermocouple element with MgO mineral insulated metal sheathed cable, providing excellent stability and reproducibility.

Sensor diameters up to 12,7mm.

Technical specification assembly

- Connection head aluminium (C200-C201-C202-C203-C260-C262).
- Ambient temperature range assembly: -45/+80 °C; this can be limited depending on the materials applied or in case a temperature transmitter is used.
- IP-68 protection degree (body – cover) with silicone rubber O-ring. The assembly protection degree (IP-68) can be attained but depends on the use of correct cable gland(s) and on the correct mounting to thermowells.
- Cover: hinged type or screw type with chain.
- Several sensor diameters and lengths are possible.

Table 1: Configuration

Connection head type

Choice between:

- Connection head types C200 / C201 / C202 / C203 with hinged type cover with 1 or 2 conduit openings.
- Connection head types C260 / C262 with screw type cover with 1 or 2 conduit openings.
- Connection head supplied with O-ring in silicone rubber (between body and cover).

	Conduit	Material	Coating	Colour
C200	00A1 1x conduit	Aluminium	Epoxy Corrosion category EN ISO 12944-2: C4	RAL9002 Grey white
C201	01A1 1x conduit	Aluminium	Epoxy Corrosion category EN ISO 12944-2: C4	RAL9002 Grey white
C200/201	00A2/01A2 2x conduits	Aluminium	Epoxy Corrosion category EN ISO 12944-2: C4	RAL9002 Grey white
C202	02S1 1x conduit	Polyamide PA6	None	Blue
C203	03S1 1x conduit	Polyamide PA6	None	Blue
C260	60B1 1x conduit	Aluminium	Epoxy Corrosion category EN ISO 12944-2: C4	RAL9002 Grey white
C262	62B2 2x conduits	Aluminium	Polyurethane spray on primer Corrosion category EN ISO 12944-2: C5-M	RAL7035 Light grey

Table 2: Measuring inserts main models

	Terminal	Total spring	
PAA	Ceramic spring loaded terminal block 2/3/4/6 or 8 terminals	10 mm We recommend a spring loading of +/-5 mm	
PBB	Hi-tech spring loaded thermoplast (moisture and shock proof) terminal block 2/3/4 or 6 terminals	40 mm We recommend a spring loading of +/-20 mm	
PBA	Hi-tech spring loaded thermoplast (moisture and shock proof) terminal block 2/3/4 or 6 terminals	10 mm We recommend a spring loading of +/-5 mm	
PEA	Spring loaded mounting plate with flying leads of 150 mm	10 mm We recommend a spring loading of +/-5 mm	

Table 3: Measuring inserts details

Details

- Maximum temperature: 550 °C
- Minimum insulation resistance: 1000 MOhm at 500VDC, T_{amb}=20 °C
- Conductors: material Cu
- Metal sheath: SS321 / 1.4541

PT100 element

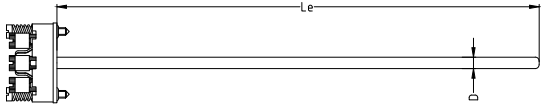
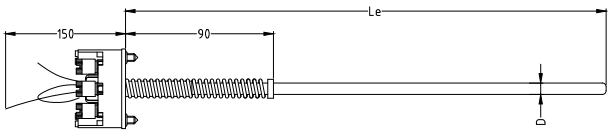
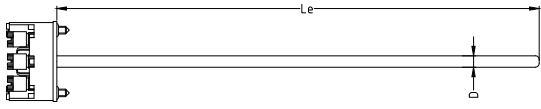
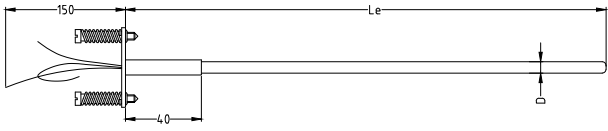
S	D	Option	HV
Single	Double		High vibration

Diameter ØD

D3	D3,2	D4,5	D4,8	D6	D6,35	D8	D9,53	D12,7	Other diameters on request
3,0 mm	3,2 mm	4,5 mm	4,8 mm	6,0 mm	6,35 mm	8,0 mm	9,53 mm	12,7 mm	

Electrical connection

W2	W3	W4 (*)	(*) for OD 3 mm: dual sensors max 2x3 wire
2 wire	3 wire	4 wire	

Accuracy

A1	A3	A5	A6	A10	Other accuracies on request
Class A IEC EN 60751 $\pm(0.15+0.002 t)^{\circ}\text{C}$	1/3 DIN 1/3 class B	1/5 DIN 1/5 class B	1/6 DIN 1/6 class B	1/10 DIN 1/10 class B	

Table 4: Thermowell–Protection tube

Protection tube

Stainless steel tube with 3 mm welded plug with rotatable or not-rotatable connection to head. Threaded connection to the process.

Material Protection tube

M2108	M2102	M2110/8	M0601	M0805	Other materials on request
SS316L	SS304L	SS310/310S	Inconel 600	Hastelloy C276	

Dimensions Protection tube

D0610	D0810	D1015	D1215	D1425	Other dimensions on request
6 mm OD x Wall 1 mm	8 mm OD x Wall 1 mm	10 mm OD x Wall 1,5 mm	12 mm OD x Wall 1,5 mm	14 mm OD x Wall 2,5 mm	

Positioning connection head

YR	Rotatable connection head
NR	Fixed connection head

Process connection

P163	P173	P205	P206	P207	P405	P406	P407
M18 x 1,5	M20 x 1,5	G1/2"	G3/4"	G1"	½"NPT	¾"NPT	1"NPT

Dimensions extension tube

OD tube		X
STD	... mm	X
Same as tube	Reinforced	Length in mm

Insertion length

U	Length in mm
----------	--------------

Table 5: Connection head details

Connection head single/double conduits (SC/DC)

SC173	SC405	DC173	DC405
1X M20x1.5	1X ½"NPT	2x M20x1.5	2X ½"NPT

Table 6: Connection head accessories

DC heads

- **For DC connection heads: One conduit plugged**
Please use the following code

Material	Brass	PM0200
	Nickel plated brass	PM0210
	Stainless steel SS316	PM2107

Table 7: Certification possibilities

Certificates

Following tests and certificates are possible and are either done in-house or done by an external party.

Code	Certificates
Q04210	Functional test report sensor
Q04230	Calibration report (measuring points to be indicated) E.g. 0/100 °C
Q05220	Calibration report by accredited calibration lab retraceable (measuring points to be indicated)
Q05230	Calibration report by accredited calibration lab ISO/IEC 17025 (BELAC) (measuring points to be indicated)
Q02040	Test report EN10204-2.2
Q04250	Transmitter programming. Range and burn-out settings to be indicated

HOW TO ORDER (example)

Code		Example	Your code
Configuration	See table 1	C262	
Main model	See table 2	PAA	
Pt100 element	See table 3	S	
Diameter ØD	See table 3	D6	
Electrical connection	See table 3	W3	
Accuracy	See table 3	A1	
Material protection tube	See table 4	M2108	
Dimensions protection tube	See table 4	D1215	
Positioning connection head	See table 4	YR	
Process connection	See table 4	P205	
Dimensions extension tube	See table 4	STD	
Extension length X	See table 4	X100	
Insertion length U (mm)	See table 4	U200	
Connection head SC/DC	See table 5	SC173	
Connection head accessories	See table 6	PM0200	

Ordering code example:

C262 PAA S D6 W3 A1 M2108 D1215 YR P205 STD X100 U200 SC173 PM0200

For all options: please contact Rodax

© 2018

Santvoortbeeklaan 33, 2100 Antwerp - Belgium

T +32 (0)3 360 90 00

E quotationdesk@rodax-europe.com

www.rodax-europe.com

RODAX[®]
new temperature solutions

All information contained herein is intended for guidance purposes only, and characteristics of the products and certification described in this publication can be changed at any time without notice. Products and certification may not be available for your local area. Please contact your local sales representative for availability information. RODAX NV diligently strives to provide as accurate information as possible, but shall not be responsible for any typographical error.

C200-Gen-RTD GB 201811