

Spring loaded thermocouple

FOR USE WITH THERMOWELLS

S300-301-304-305-360-361-362-363
CONFIGURATIONS

Ex ia TC

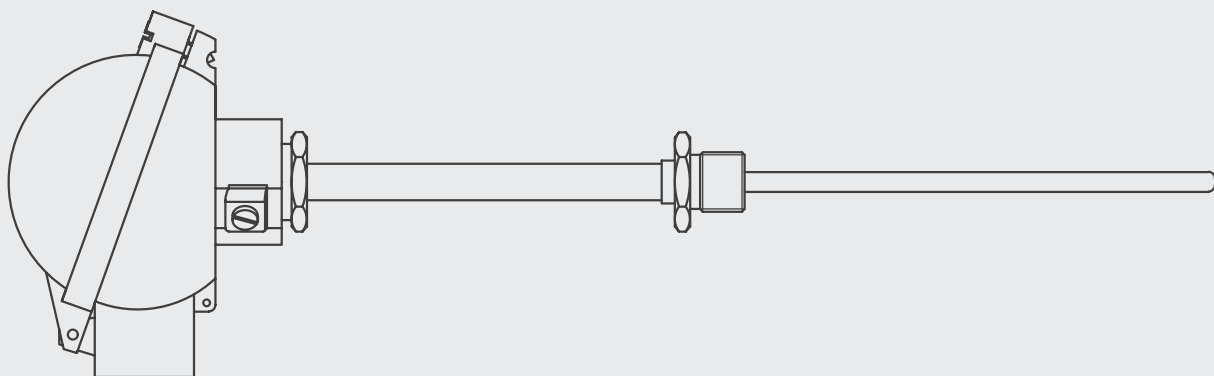

RODAX^o
new temperature solutions

Product series TCRI/WI

S300

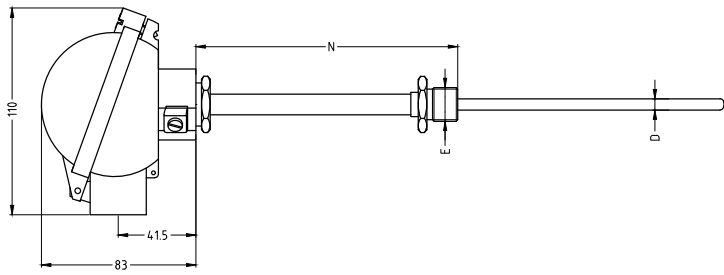

S301

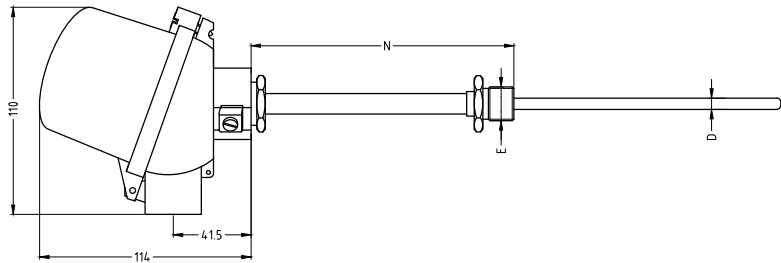

S304

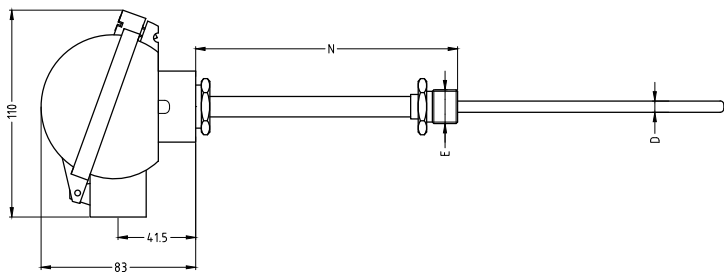

S305

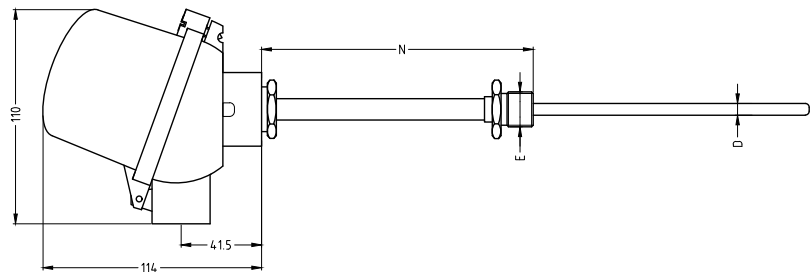

S360 & S361

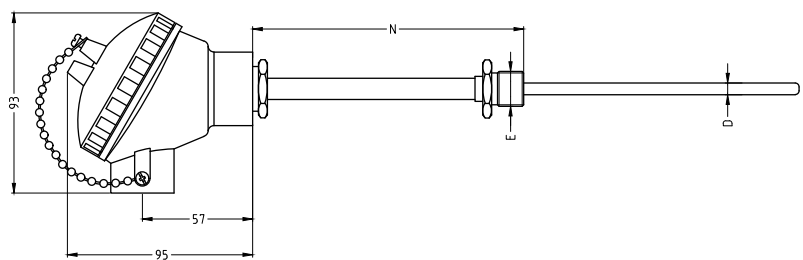

S362 & S363

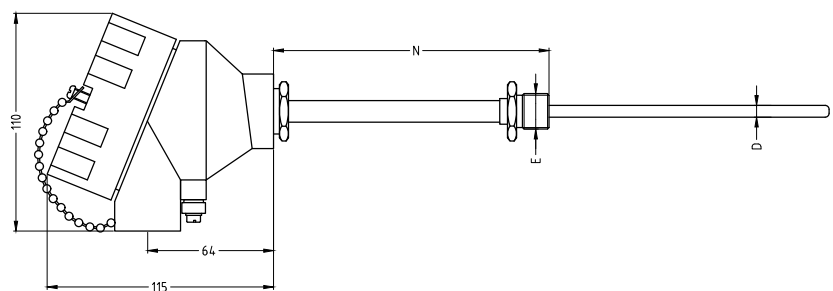

Features assembly

The industrial spring loaded configuration guarantees a positive contact between the sensing part of the temperature probe and the bottom of the thermowell, thus reducing the response time. In order to calculate the correct element length, we need the Z-length: this is the total bore depth of the thermowell.

The assemblies can be delivered with an aluminium or stainless steel connection head combined with a high quality thermocouple element with MgO mineral insulated metal sheathed cable, providing excellent stability and reproducibility.

Sensor diameters up to 12,7mm.

Technical specification assembly

- Connection head aluminium (S300-S301-S304-S305-S360-S362) or SS316 (S361-363).
- Ambient temperature range assembly: -45/+80 °C; this can be limited depending on the materials applied or in case a temperature transmitter is used.
- IP-68 protection degree (body – cover) with silicone rubber O-ring. The assembly protection degree (IP-68) can be attained but depends on the use of correct cable gland(s) and on the correct mounting to thermowells.
- Cover: hinged type or screw type with chain.
- Several sensor diameters and lengths are possible.

Table 1: Configuration

Connection head type

Choice between:

- Connection head types S300 / S301 / S304 / S305 with hinged type cover with 1 or 2 conduit openings.
- Connection head types S360 / S361 / S362 / S363 with screw type cover with 1 or 2 conduit openings.
- Connection head supplied with O-ring in silicone rubber (between body and cover). Head supplied with external earth terminal.

	Conduit	Material	Coating	Colour
S300	00C1 1x conduit	Aluminium	Epoxy Corrosion category EN ISO 12944-2: C4	RAL5015 Sky blue
S301	01C1 1x conduit	Aluminium	Epoxy Corrosion category EN ISO 12944-2: C4	RAL5015 Sky blue
S300/301	00C2/01C2 2x conduits	Aluminium	Epoxy Corrosion category EN ISO 12944-2: C4	RAL5015 Sky blue
S304	04S1 1x conduit	Polyamide PA12 (Antistatic)	None	Black
S305	05S1 1x conduit	Polyamide PA12 (Antistatic)	None	Black
S360	60C1 1x conduit	Aluminium	Epoxy Corrosion category EN ISO 12944-2: C4	RAL5015 Sky blue
S361	61S1 1x conduit	SS316	None	SS316 natural colour
S362	62C2 2x conduits	Aluminium	Polyurethane spray on primer Corrosion category EN ISO 12944-2: C5-M	RAL5015 Sky blue
S363	63S2 2x conduits	SS316	None	SS316 natural colour

Table 2: Measuring inserts main models

	Terminal	Total spring	
TCCC	Ceramic spring loaded terminal block 2/4/6 or 8 terminals	10 mm We recommend a spring loading of +/-5 mm	
TCCB	Hi-tech spring loaded thermoplast (moisture and shock proof) terminal block 2/4 or 6 terminals	40 mm We recommend a spring loading of +/-20 mm	
TCCA	Hi-tech spring loaded thermoplast (moisture and shock proof) terminal block 2/4 or 6 terminals	10 mm We recommend a spring loading of +/-5 mm	
TCFA	Spring loaded mounting plate with flying leads of 150 mm	10 mm We recommend a spring loading of +/-5 mm	

Table 3: Equipment for potentially explosive atmospheres

Certification

A	ATEX
I	IECEX
G	GOST-R

Explosive atmosphere

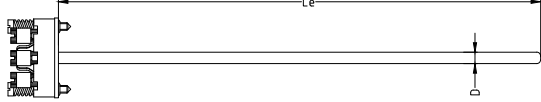
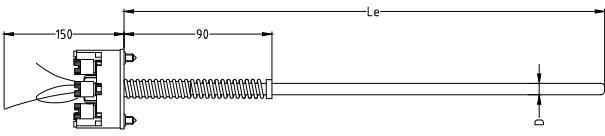
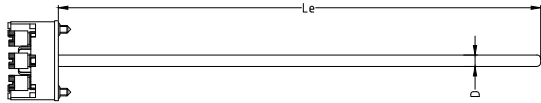
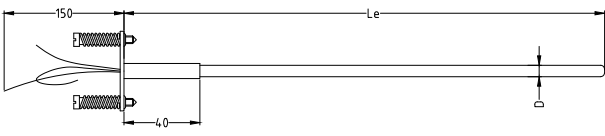
G	Gas
D	Dust

Table 4: Measuring inserts details

Details

- Thermocouple types: J/K/T/E/N/S/R/B
- Thermocouple standards: EN/IEC 60584 and/or ANSI MC96-1
- Minimum insulation resistance: 1000 MOhm at 500VDC, $T_{amb}=20\text{ }^{\circ}\text{C}$
- Conductors: thermocouple material
- Metal sheath: see table

TC Type

J	K	T	E	N
Fe – CuNi	NiCr – NiAl	Cu – CuNi	NiCr – CuNi	NiCrSi – NiSi
±1.5 between -40 °C and 375 °C or ±0.004xT °C	±1.5 between -40 °C and 375 °C or ±0.004xT °C	±0.5 between -40 °C and 125 °C or ±0.004xT °C	±1.5 between -40 °C and 375 °C or ±0.004xT °C	±1.5 between -40 °C and 375 °C or ±0.004xT °C

Colour code

ANSI	IEC	Other
ANSI – MC96-1	EN/IEC 60584-1	

TC element

S	D	T
Single thermocouple	Dual thermocouple	Triple thermocouple

Diameter ØD

D3	D3,2	D4,5	D4,8	D6	D6,35	D8	D9,53	D12,7	Other diameters on request
3,0 mm	3,2 mm	4,5 mm	4,8 mm	6,0 mm	6,35 mm	8,0 mm	9,53 mm	12,7 mm	

Sheath material

M2102	M2107	M2110	M0601	M0701	M0704	M0809
SS304	SS316 Standard for TC J/T	SS310	Inconel 600 Standard for TC K	Alloy 800H	Alloy 825	Hastelloy X

Hot junction

I	Individually isolated	Hot junction electrically isolated from and shielded by the sheath.
CI	Commonly isolated	Multiple hot junctions joined to one hot junction electrically isolated from and shielded by the sheath.
DI	Dually isolated	Hot junction electrically isolated from and shielded by the sheath. For dual and triple: all circuits isolated from each other and from the sheath.
G	Grounded	Hot junction welded to the sheath.

Table 5: Extension details (E and N)

Details

Extension nipple with standard length N of 110 mm and standard outside diameter of 12 mm and material stainless steel SS316L. Other dimensions on request.

Extension connection (E)

E205	E405	Other dimensions on request
G1/2"	1/2"NPT	

Extension length (N) + outside diameter (OD)

N110	OD12	Other lengths on request
110 mm	12 x 1,5 mm	

Total bore depth thermowell

Definition total bore depth thermowell (Z) in mm below.

	Z.....
 mm

Table 6: Connection head details

Connection head single/double conduits (SC/DC)

SC173	SC405	DC173	DC405
1X M20x1.5	1X 1/2"NPT	2x M20x1.5	2X 1/2"NPT

Table 7: Connection head accessories

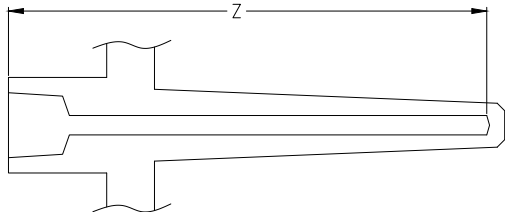
Available options

- **Option 1: For SC and DC connection heads: Cable gland(s) only**

If required, a cable gland can be supplied; please use the letter 'CG' (cable gland) followed by the material of the cable gland and used cable diameter. Specification see below table.

The offered cable glands are II2 G Ex d/e IIC Gb and II 2D Ex tb IIIC Db IP66 certified and can be combined with configured products in this datasheet.

For SC heads, only option 'one cable gland' is possible. For DC heads, both one and two cable glands are possible.

- **Option 2: For DC connection heads: One conduit plugged**

Please use the letter 'P' (plug) followed by the material of the plug, see below table. The remaining conduits stay open.

- **Option 3: For DC connection heads: Cable gland + one conduit plugged**

Please use the combination 'PCG' (plug cable gland) followed by the material of the plug and cable gland, see below table.

		Option 1	Option 2	Option 3
Material	Brass	CGM0200	PM0200	PCGM0200
	Nickel plated brass	CGM0210	PM0210	PCGM0210
	Stainless steel SS316	CGM2107	PM2107	PCGM2107
	Polyamide	CGM5006		CGM5006
Cable diameter for EPDM rubber	4 - 7 mm	D5		D5
	7 - 9,5 mm	D8		D8
	9 - 12 mm	D10		D10
	7 - 13 mm	D9 (only for CGM5006)		D9 (only for CGM5006)
Glands N°	One cable gland	N1		
	Two cable glands	N2		

Table 8: Certification possibilities

Certificates

Following tests and certificates are possible and are either done in-house or done by an external party.

Code	Certificates
Q04210	Functional test report sensor
Q04230	Calibration report (measuring points to be indicated) E.g. 100/200 °C
Q05220	Calibration report by accredited calibration lab retraceable (measuring points to be indicated)
Q05230	Calibration report by accredited calibration lab ISO/IEC 17025 (BELAC) (measuring points to be indicated)
Q02040	Test report EN10204-2.2
Q04250	Transmitter programming. Range and burn-out settings to be indicated



Addenda

Thermal data related to product series TCRI/WI

The maximum process temperature T_p (in °C) and the relation to the temperature class is as follows:

Maximum process temperature T_p (°C)	75	90	125	190	285	435	>435
Temperature class (°C)	T6	T5	T4	T3	T2	T1	T_p+10
Maximum surface temperature T of the Assembly (°C)	85	100	135	200	300	450	T_p+10

Certificates for product series TCRI/WI

ATEX 2014/34/EU	ATEX EU-type examination certificate 18ATEX0060 X	
IECEX 02	IECEX DEK 18.0032 X	
GOST-R	GOST EAC RU C-BE.ГБ05B.00211	

HOW TO ORDER (example)

Code		Example	Your code
Configuration	See table 1	S301	
Main model	See table 2	KCA	
Certification	See table 3	A	
Explosion atmosphere	See table 3	G	
TC type	See table 4	K	
Colour code	See table 4	IEC	
TC element	See table 4	D	
Diameter ØD	See table 4	D6	
Sheath material	See table 4	M0601	
Hot junction	See table 4	I	
Extension connection	See table 5	E405	
Extension length	See table 5	N110	
Outside diameter OD	See table 5	OD12	
Total bore depth thermowell	See table 5	Z1000	
Connection head SC/DC	See table 6	SC173	
Connection head accessories	See table 7	CGM0200D5N2	

Ordering code example:

S301 KCA A G K IEC D D6 M0601 I E405 N110 OD12 Z1000 SC173 CGM0200D5N2

For all options: please contact Rodax

© 2018

Santvoortbeeklaan 33, 2100 Antwerp - Belgium

T +32 (0)3 360 90 00

E quotationdesk@rodax-europe.com

www.rodax-europe.com

RODAX[°]
new temperature solutions

S300-Exia-TC GB 201810